



Goldstein

800 SERIES RANGES 500mm GAS STATIC OVEN

PF420-X, PF12G220-X, PF24G20-X
PF12Q220-X, PF24Q20-X



Standard features and benefits



- Heavy duty welded stainless steel body for rigidity and durability
- Fully welded surrounds for griddle and chargrill option
- The flexible modular cooktop design allows for various combinations of burners, griddle plates, and chargrill options (305, 610mm)
- Gas or electric static oven, fan forced oven and convection oven options are available, all in gastronorm compatible sizes
- Constant pilot flame, maximises operating and energy efficiency
- Pilot flame failure on open burners, flame failure to oven burner
- Stainless steel fascia and sides, spill zone and drip trays for ease of cleaning
- Large, heat resistant reinforced control knob with easy to view settings and high to low flame control
- Ergonomic door handle and angled corners create a sleek look
- Griddle and BBQ section are on left hand side
- Adjustable legs 140-170mm
- Easy to service

Burners

- Removable, high performance, even heat 33 MJ cooktop burners for peak productivity
- 40% of the flame ports are in the centre cross of the burner
- Cast iron star trivets

Griddle plate

- 20mm thick mild steel griddle plate
- 20 MJ griddle burners per every 305mm section
- Piezo ignition

Chargrill

- Heavy duty cast iron reversible grates provide greater control when cooking, energy efficiency, and offer two char pattern options
- 2 levelling options - flat or gradient
- 2x 20 MJ inline radiant burners per every 305mm section
- Ceramic rocks option available to increase heat retention and flavour

Oven

- 100°C - 280°C thermostatic control
- Piezo ignition
- Oven and door are fully insulated with vitreous enamel for even heat distribution and easy cleaning
- GN 1/1 capacity with 3 position racking
- Heavy duty chrome wire rack supports designed for easy removal

Oven Options

- Gas static and fan forced oven
- Electric static and fan forced oven



Cert. No.
AGA 7732



MIDDLEBY GOLDSTEIN

1800 013 123 | +61 2 9604 7333
sales@middleby.com.au
middleby.com.au

VIC - TAS - 47 Stubbs Street, Kensington VIC 3031
QLD - U12, 210 Queensport Rd Nth, Murarrie QLD 4172
WA - U2, 9 Meares Way, Canning Vale WA 6155

**HEAD OFFICE
AND MANUFACTURING PLANT**
211-217 Woodpark Road, Smithfield NSW 2164

v1_2024



PF420-X, PF12G220-X, PF24G20-X, PF12Q220-X, PF24Q20-X

800 SERIES RANGES 500mm GAS STATIC OVEN

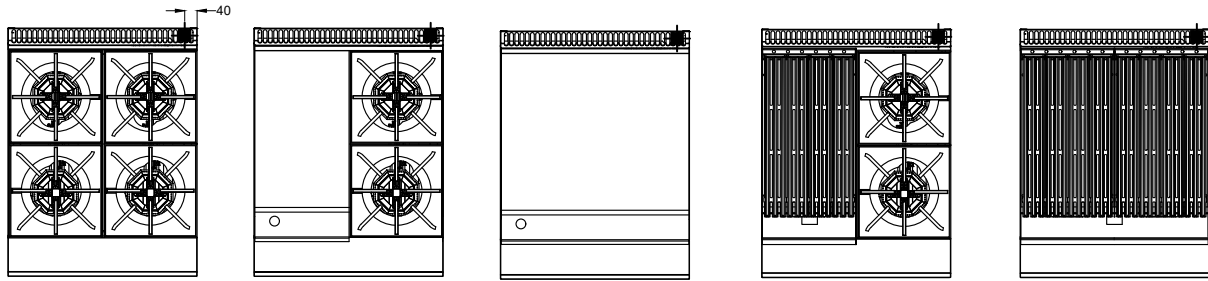
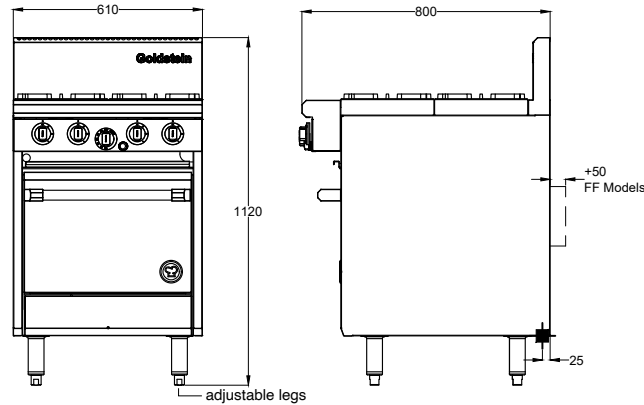

PF420-X

PF12G220-X

PF24G20-X

PF12Q220-X

PF24Q20-X

3/4" BSP Gas Connection

SPECIFICATIONS

Dimensions (WxDxH)	610 x 800 x 1120 mm	
Working height	914 mm	
Oven size (WxDxH)	500 x 560 x 355 mm	
Oven Rack Positions	3	
Griddle size	PF12G220-X	305 x 520 x 20 mm
	PF24G20-X	610 x 520 x 20 mm
Grill size	PF12Q220-X	305 x 510 mm
	PF24Q20-X	610 x 510 mm

Gas connection	3/4" BSPM	
Rating NG/LPG	PF420-X	152/152 MJ
	PF12G220-X	106/106 MJ
	PF24G20-X	60/60 MJ
	PF12Q220-X	126/124 MJ
Packed dimensions	PF24Q20-X	100/96 MJ
	720 x 920 x 1200 mm	

Available in Natural and LP gas

INSTALLATION CLEARANCES (minimum)

Combustible Material	Sides	250* mm	Non-combustible Material	Sides	0 mm
	Back	50 mm		Back	0 mm

Note: * If adjacent surface is of combustible material and is 100mm below the cooking surface, then only 50mm clearance is required.

Please note, due to ongoing product development and improvement, we reserve the right to change product design and specification at any time without notice.



1800 013 123 | +61 2 9604 7333
sales@middleby.com.au
middleby.com.au

VIC - TAS - 47 Stubbs Street, Kensington VIC 3031
QLD - U12, 210 Queensport Rd Nth, Murarrie QLD 4172
WA - U2, 9 Meares Way, Canning Vale WA 6155

HEAD OFFICE AND MANUFACTURING PLANT
211-217 Woodpark Road, Smithfield NSW 2164

v1_2024



800 SERIES RANGES 500mm OVEN OPTIONS

Model Number	Dimensions (mm) WxDxH	Oven size (mm) WxDxH	Rating (MJ) NG/LPG	Rating (kW)
--------------	--------------------------	-------------------------	-----------------------	----------------

4 burners

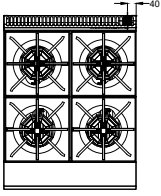

PF420FF-X Gas Fan Forced Oven	610 x 850 x 1120	500 x 525 x 355	152/152	
PF420E-X Electric Static Oven	610 x 800 x 1120	500 x 560 x 305	132/132	5.4
PF420EFF-X Electric Fan Forced Oven	610 x 850 x 1120	500 x 525 x 305	132/132	5.4

2 burners, 305mm griddle plate

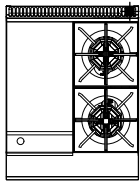

PF12G220FF-X Gas Fan Forced Oven	610 x 850 x 1120	500 x 525 x 355	106/106	
PF12G220E-X Electric Static Oven	610 x 800 x 1120	500 x 560 x 305	86/86	5.4
PF12G220EFF-X Electric Fan Forced Oven	610 x 850 x 1120	500 x 525 x 305	86/86	5.4

610mm griddle plate

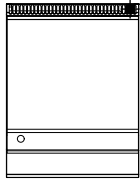

PF24G20FF-X Gas Fan Forced Oven	610 x 850 x 1120	500 x 525 x 355	60/60	
PF24G20E-X Electric Static Oven	610 x 800 x 1120	500 x 560 x 305	40/40	5.4
PF24G20EFF-X Electric Fan Forced Oven	610 x 850 x 1120	500 x 525 x 305	40/40	5.4

2 burners, 305mm chargrill

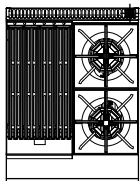

PF12Q220FF-X Gas Fan Forced Oven	610 x 850 x 1120	500 x 525 x 355	126/124	
PF12Q220E-X Electric Static Oven	610 x 800 x 1120	500 x 560 x 305	106/104	5.4
PF12Q220EFF-X Electric Fan Forced Oven	610 x 850 x 1120	500 x 525 x 305	106/104	5.4

610mm chargrill

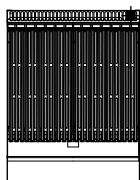

PF24Q20FF-X Gas Fan Forced Oven	610 x 850 x 1120	500 x 525 x 355	100/96	
PF24Q20E-X Electric Static Oven	610 x 800 x 1120	500 x 560 x 305	80/76	5.4
PF24Q20EFF-X Electric Fan Forced Oven	610 x 850 x 1120	500 x 525 x 305	80/76	5.4

Please note, due to ongoing product development and improvement, we reserve the right to change product design and specification at any time without notice.



1800 013 123 | +61 2 9604 7333
sales@middleby.com.au
middleby.com.au

VIC - TAS - 47 Stubbs Street, Kensington VIC 3031
QLD - U12, 210 Queensport Rd Nth, Murarrie QLD 4172
WA - U2, 9 Meares Way, Canning Vale WA 6155

HEAD OFFICE
AND MANUFACTURING PLANT
211-217 Woodpark Road, Smithfield NSW 2164

v1_2024